

# BAMBOO & BAMBOO MINI

Paletti con distribuzione luminosa radente,  
simmetrica o asimmetrica, ideale per  
l'illuminazione di aree verdi e camminamenti.

Small poles with symmetrical or asymmetrical  
grazing light distribution, ideal for lighting  
green areas and paths.





220 240V	50 60Hz	CL II	IP66 *	IP65 **	IK10 *	IK09 **	ta -30°C +50°C	CE		ROHS
-------------	------------	-------	--------	---------	--------	---------	----------------------	----	--	------

\* Bamboo  
\*\* Bamboo mini

**DATI PRESTAZIONALI / PERFORMANCE DATA**

**Flusso apparecchio / Fitting flux:**  
425 - 1000 lm

**Potenza apparecchio / Fitting power:**  
7,6 - 12 W

**Indice di resa cromatica / Colour Rendering Index:**  
CRI ≥ 80, SDCM ≤ 3

**Illuminazione intelligente / Smart lighting:**  
DALI

**TEMPERATURA COLORE  
COLOUR TEMPERATURE**

- 2700 K
- 3000 K
- 4000 K

**MATERIALI / MATERIALS**

**Corpo, collimatore e flangia di base**  
Body, collimator and fixing base:  
pressofusione di lega d'alluminio UNI EN AB 47100  
(contenuto rame < 1%) / die-cast aluminum alloy UNI  
EN AB 47100 (copper content < 1%)

**Fusto / Steam pole:**  
alluminio estruso  
extruded aluminium alloy

**Gruppo ottico / Optical unit:**  
policarbonato opale diffondente  
wide opal polycarbonate

**Finitura / Finish:**  
fosfocromatazione e verniciatura in polveri di  
poliestere realizzata in 16 fasi per la miglior resistenza  
agli agenti atmosferici / phospho-chromatation treated  
and polyester powder-coated in 16 phases to increase  
weather resistance

**COLORI / COLOURS**

- SABLÉ 100 NOIR
- RAL9006

**CARATTERISTICHE / FEATURES**

**Peso massimo / Max weight:**  
Bamboo:  
1,6 kg (grazer), 3 kg (H 400 mm), 4,6 kg (H 900 mm)  
Bamboo mini:  
0,8 kg (grazer), 1,6 kg (H 375 mm), 2,5 kg (H 895 mm)

**Alimentazione elettronica / Electronic power supply:**  
inclusa, esclusa solo nella versione Bamboo mini Grazer  
- Wall DALI / internal, external only in Bamboo mini Grazer -  
Wall DALI version

**Precablaggio / pre-wiring:**  
versione bollard fornita con cavo e connettore;  
predisposizione entra-esci  
bollard version is supplied with cable and connector;  
in and out setup

**Installazione / Installation:**  
terra, parete / ground, wall

**Fissaggio / Fixing system:**  
con tirafondi (fornibili) o tasselli / with metal anchors  
(available) or plugs



RS-D 360° Rotosymmetric Diffused Beam

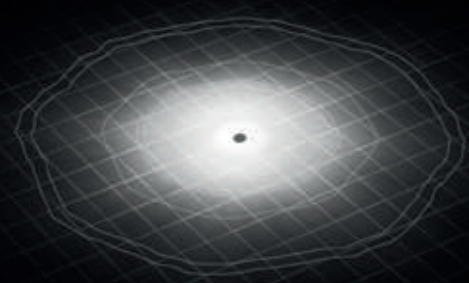

AD 180° Asymmetric Diffused Beam (only Bamboo)

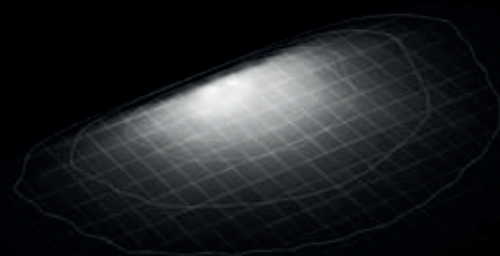

### Bamboo & Bamboo mini Bollard

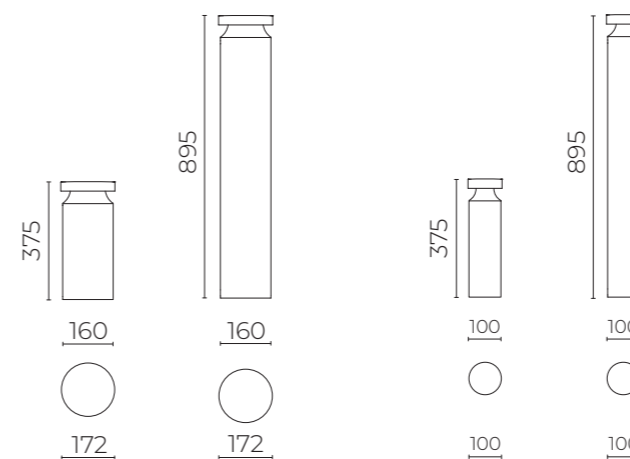

### ACCESSORI / ACCESSORIES

**06PY999X0**  
**Kit tirafondi**  
Anchoring bolts kit 30

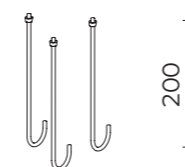

RS-D 360° Rotosymmetric Diffused Beam

AD 180° Asymmetric Diffused Beam (only Bamboo)

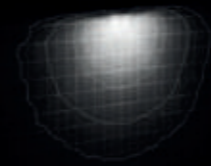
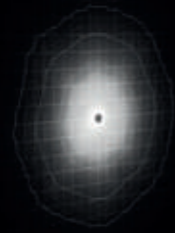

RS-D 360° Rotosymmetric Diffused Beam

AD 180° Asymmetric Diffused Beam (only Bamboo)

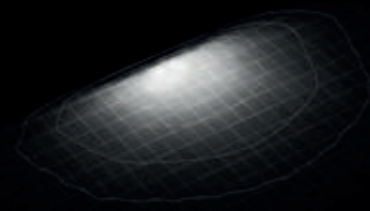
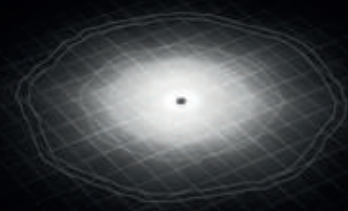

Bamboo & Bamboo mini

Wall

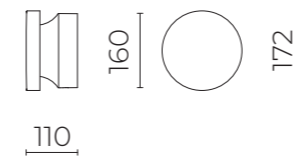

Grazer

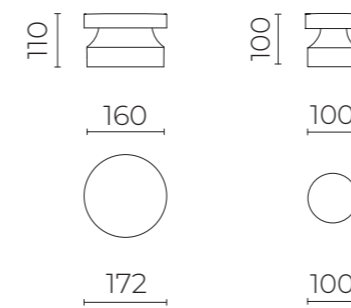

ACCESSORI / ACCESSORIES

**06BM902X0**  
Kit driver DALI per Bamboo mini / Kit  
DALI driver for Bamboo mini

